

# Open Top Trailer Roll Over Tarp Form

for Ratchet Systems

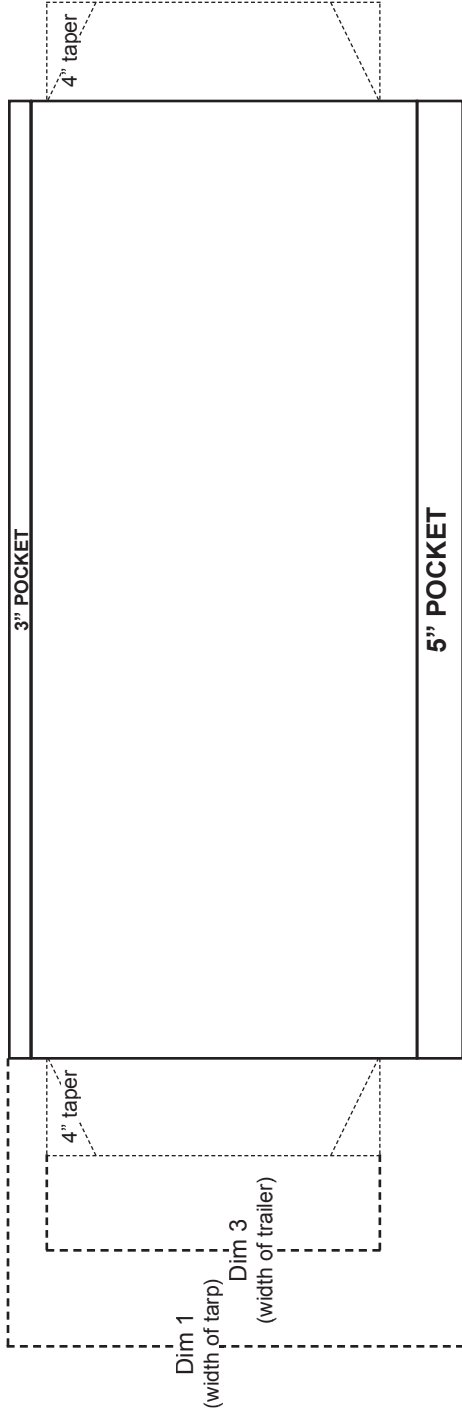

**Front & Rear Flaps**

- Standard length = 18"
- Custom length = \_\_\_\_\_"

- Squared flaps with 10' straps



- Tapered flaps with 10' straps



- Squared flaps with grommets

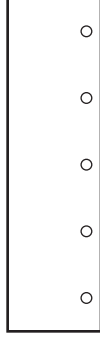

- Tapered flaps with grommets



**Material Type**

- Mighty Mesh®
  - Gator Mesh\*\*
  - HD Black Mesh\*\*
  - 18oz Vinyl (black)
  - 22oz Vinyl (black)
- \*\* Gator Mesh and HD Black Mesh tarps include vinyl reinforced front and rear flaps

**Tarp Upgrades**

- 2" webbing reinforced pockets
- Vinyl reinforced pockets
- Vinyl reinforced flaps

**Trailer Length & Width**

Trailer width \_\_\_\_\_"  
 Trailer length \_\_\_\_\_"

**Tarp Length & Width**

Dim 1 \_\_\_\_\_ width of tarp  
 Dim 2 \_\_\_\_\_ length of tarp  
 Dim 3 \_\_\_\_\_ width of trailer

Other information: \_\_\_\_\_



Toll Free: 800-327-8287 ▪ Fax: 772-287-0431 ▪ www.donovan-ent.com

# Side Roller Specifications and Measurements

## Contact Info

Name \_\_\_\_\_  
 Address \_\_\_\_\_  
 City \_\_\_\_\_ State \_\_\_\_\_ Zip \_\_\_\_\_  
 Phone \_\_\_\_\_ Fax \_\_\_\_\_

## Trailer / Box Info.

Trailer / Box Make: \_\_\_\_\_ Model: \_\_\_\_\_ Year: \_\_\_\_\_

Transport Usage:  Waste  Grain / Produce  Rock / Gravel / Sand  Other  
 Style:  Live Floor  Open Top Van  End Dump  Belly Dump  
 Grain Hopper

Body Construction:  Aluminum  Steel

## Roll Over Tarp System Info.

System Style:  Quick Lock  Ratchet  
 Caps:  Front  Rear  
 Bows:  7" LR (Low Rise) Steel  12" HR (High Rise) Steel  
 7" LR Heavy Duty  12" HR Heavy Duty  Flex Bows

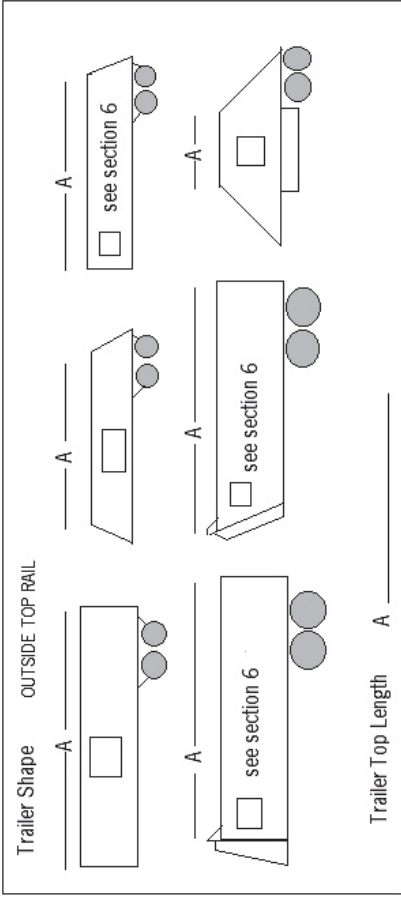
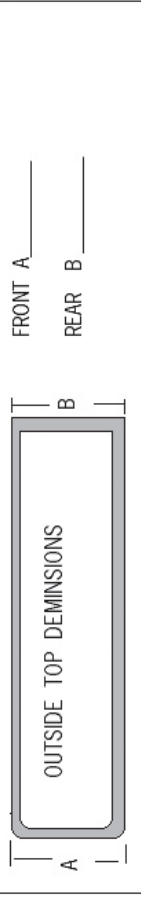
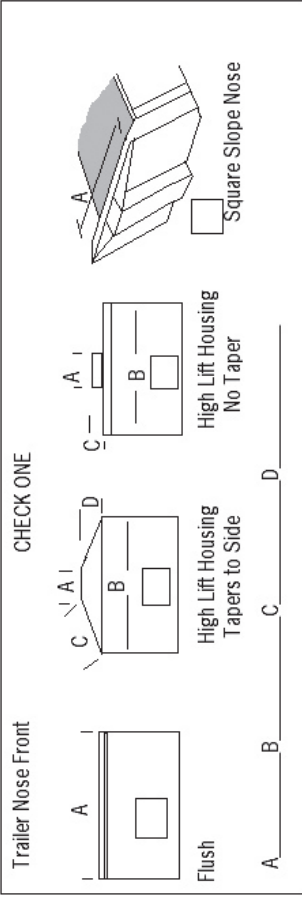
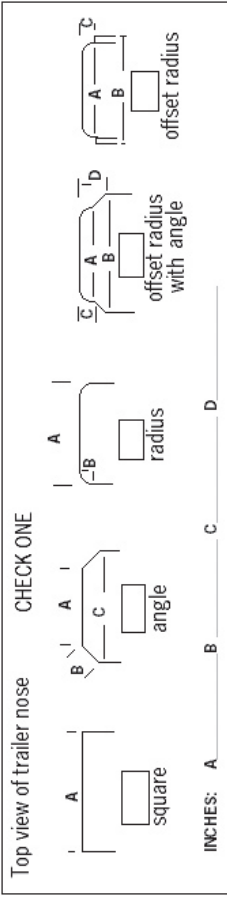
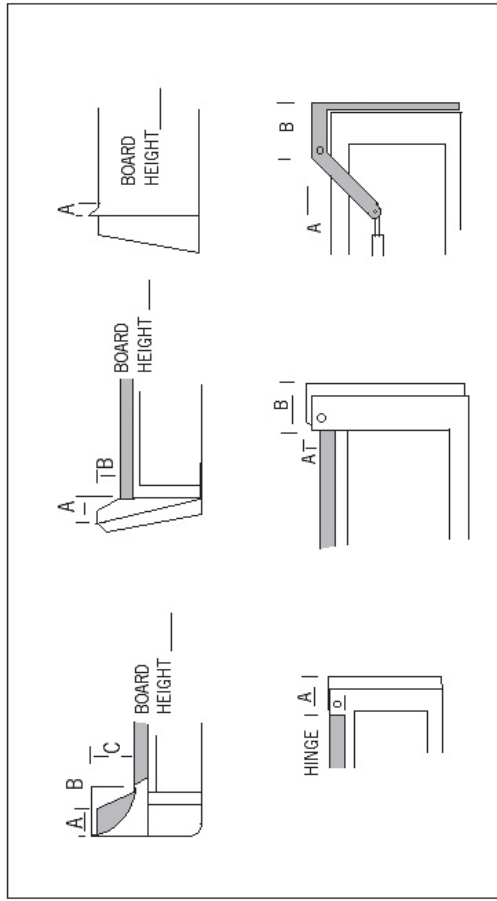

Please take accurate measurements.

Make sure that all measurements are taken at the top of the trailer, not at the bottom.

Print Name: \_\_\_\_\_

Signature: \_\_\_\_\_

Date: \_\_\_\_\_

I CONFIRM THAT THE ABOVE SPECIFICATIONS AND MEASUREMENTS ARE ACCURATE AND COMPLETE.